

BAR mXTEND™ (FR01-S4-232) – A standard antenna solution for mobile frequency bands

Fractus Antennas specializes in enabling effective mobile communications. Using Fractus Antennas technology, we design and manufacture optimized antennas to make your wireless devices more competitive. Our mission is to help our clients develop innovative products and accelerate their time to market through our expertise in antenna design, testing and manufacturing.



BAR mXTEND™ Antenna Booster

FR01-S4-232

Fractus Antennas products are protected by [Fractus Antennas patents](#).

All information contained within this document is property of Fractus Antennas and is subject to change without prior notice. Information is provided “as is” and without warranties. It is prohibited to copy or reproduce this information without prior approval.

Fractus Antennas is an ISO 9001:2015 certified company. All our antennas are lead-free and RoHS compliant.

ISO 9001: 2015 Certified



INDEX OF CHAPTERS

1. PRODUCT DESCRIPTION FR01-S4-232.....	4
2. EVALUATION BOARD 3 PORTS (698-798MHz, 824-960MHz, 1710-2690MHz)	5
3. EVALUATION BOARD 1 PORT (824-960MHz and 1710-2690MHz).....	12
4. CAPABILITIES AND MEASUREMENT SYSTEMS.....	17
5. MECHANICAL CHARACTERISTICS FR01-S4-232.....	18
6. ASSEMBLY PROCESS.....	20
7. PACKAGING.....	22

TABLE OF CONTENTS

1. PRODUCT DESCRIPTION FR01-S4-232.....	4
2. EVALUATION BOARD 3 PORTS (698-798MHz, 824-960MHz, 1710-2690MHz)	5
2.1. QUICK REFERENCE GUIDE	5
2.2. EVALUATION BOARD 3 PORTS.....	5
3. EVALUATION BOARD 1 PORT (824-960MHz and 1710-2690MHz).....	12
3.1. QUICK REFERENCE GUIDE	12
3.2. EVALUATION BOARD 1 PORT (824-960 MHz and 1710-2690 MHz).....	12
4. CAPABILITIES AND MEASUREMENT SYSTEMS	17
5. MECHANICAL CHARACTERISTICS FR01-S4-232.....	18
5.1. DIMENSIONS, TOLERANCES, AND RoHS	18
5.2. COLOUR RANGE FOR THE INK.....	18
5.3. RECOMMENDED FOOTPRINT for the FR01-S4-232	19
5.4. RECOMMENDED FOOTPRINT for the FR01-S4-232 double booster.....	19
6. ASSEMBLY PROCESS.....	20
7. PACKAGING	22

1. PRODUCT DESCRIPTION FR01-S4-232

The BAR mXTEND™ Antenna Booster has been specifically designed for providing multiband performance in wireless devices (in particular in mobile devices), enabling worldwide coverage by allowing operation in the communication standards GSM850, GSM900, GSM1800/DCS, GSM1900/PCS, UMTS, LTE700, LTE800, LTE850, LTE900, LTE1700, LTE1800, LTE1900, LTE2000, LTE2100, LTE2300, LTE2500, and LTE2600.

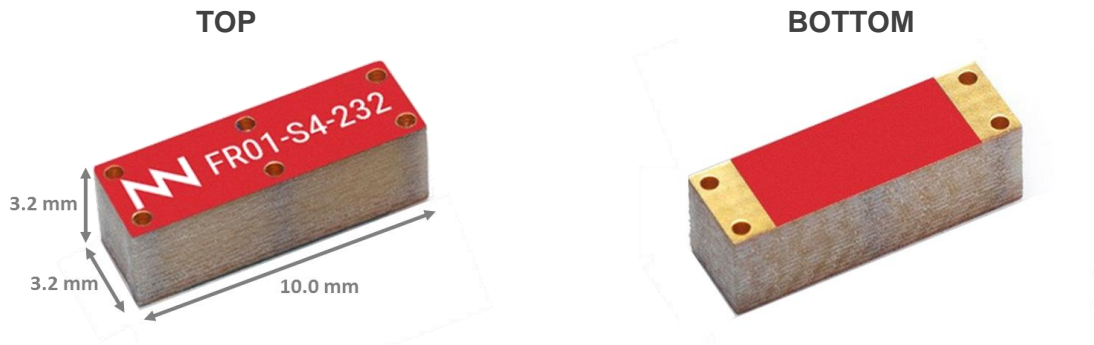

Material: The BAR mXTEND™ Antenna Booster is built on glass epoxy substrate.

APPLICATIONS

- Handsets
- Smartphones
- Tablets
- Phablets
- Laptop PCs
- Netbooks
- Modules
- Routers
- eBooks

BENEFITS

- High efficiency
- Small size
- Cost-effective
- Easy-to-use (pick and place)
- Multiband behaviour (worldwide standards)
- Off-the-Shelf Standard Product (no customization is required)

The BAR mXTEND™ Antenna Booster belongs to the new generation of antenna solutions based on the Virtual Antenna™ technology owned by Fractus Antennas. The technology is mainly focused on replacing conventional antenna solutions by miniature and standard components.

2. EVALUATION BOARD 3 PORTS (698-798MHz, 824-960MHz, 1710-2690MHz)

2.1. QUICK REFERENCE GUIDE

Technical features	698 – 798 MHz	824 – 960 MHz	1710 – 2690 MHz
Average Efficiency	> 45.0 %	> 40.0 %	> 75.0 %
Peak Gain	1.3 dBi	0.3 dBi	3.8 dBi
VSWR	< 3:1		
Radiation Pattern	Omnidirectional		
Polarization	Linear		
Weight (approx.)	0.21 g		
Temperature	-40 to + 85 °C		
Impedance	50 Ω		
Dimensions (L x W x H)	10.0 mm x 3.2 mm x 3.2 mm		

Table 1 – Technical features. Measures from the Evaluation Board. See Figure 1. Note that for obtaining comparable results, a ground plane length larger than 100 mm is recommended.

2.2. EVALUATION BOARD 3 PORTS

This Evaluation Board (part number: EB_FR01-S4-232-UFL3R) integrates UFL cables to connect the BAR mXTEND™ Antenna Boosters with the SMA connector. It works from 698 MHz to 798 MHz, from 824 MHz to 960 MHz, and from 1710 MHz to 2690 MHz.

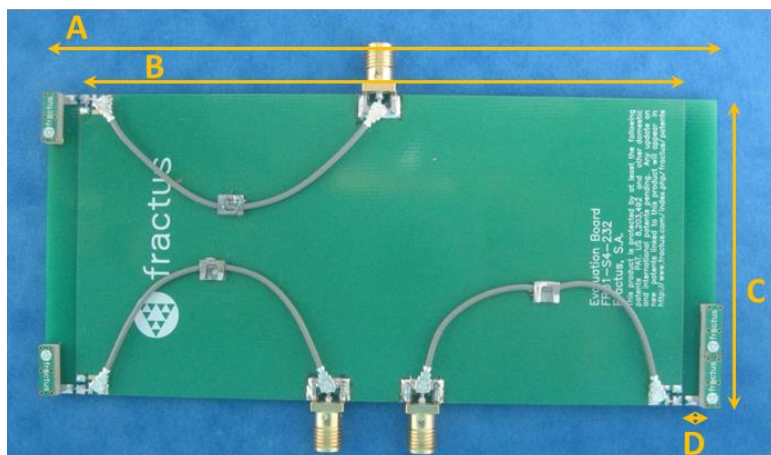

Measure	mm
A	133
B	120
C	60
D	3.3

Tolerance: ±0.2 mm

D: Distance between the BAR mXTEND™ Antenna Booster and the ground plane.

Material: The Evaluation Board is built on FR4 substrate. Thickness is 1 mm.

Figure 1 – EB_FR01-S4-232-UFL3R. Evaluation Board providing operation in 3 frequency ranges, 698 MHz to 798 MHz, 824 MHz to 960 MHz, and 1710 MHz to 2690 MHz.

This product is protected by at least the following [patents](#) PAT. US 8,203,492, PAT. US 8,736,497 and other domestic and international patents pending. Any update on new patents linked to this product will appear in www.fractusantennas.com/virtual-antenna/.

Comments:

- Note that in this case the Evaluation Board (Figure 1) integrates two BAR mXTEND™ Antenna Boosters that are placed together to provide operation at LTE700 (698 – 798 MHz). Please see Figure 10 for the recommended footprint.
- The efficiency measures (Figure 3) are shown from 700 MHz due to the minimum frequency specifications of the Satimo STARGATE 32 anechoic chamber.

2.2.1. MATCHING NETWORK

The specs of a Fractus Antennas standard product are measured in their Evaluation Board, which is an ideal case. In a real design, components nearby the antenna, LCD's, batteries, covers, connectors, etc. affect the antenna performance. This is the reason why it is highly recommended to place pads compatible with 0402 and 0603 SMD components for a matching network as close as possible to the feeding point. Do it in the ground plane area, not in the clearance area. This provides a degree of freedom to tune the BAR mXTEND™ Antenna Booster once the design is finished and taking into account all elements of the system (batteries, displays, covers, etc.).

Please notice that different devices with different ground planes and different components nearby the BAR mXTEND™ Antenna Booster may need a different matching network. To ensure optimal results, the use of high Q and tight tolerance components is highly recommended (Murata components).

Matching network for the Evaluation Board											
698 – 798 MHz	 <table border="1" style="float: right;"> <thead> <tr> <th>Value</th> <th>Part Number</th> </tr> </thead> <tbody> <tr> <td>36 nH</td> <td>LQW18AN36NG00</td> </tr> <tr> <td>2.5 nH</td> <td>LQW15AN2N5B80</td> </tr> <tr> <td>6.8 pF</td> <td>GJM1555C1H6R8WB01</td> </tr> <tr> <td>3.6 nH</td> <td>LQW15AN3N6B80</td> </tr> </tbody> </table>	Value	Part Number	36 nH	LQW18AN36NG00	2.5 nH	LQW15AN2N5B80	6.8 pF	GJM1555C1H6R8WB01	3.6 nH	LQW15AN3N6B80
Value	Part Number										
36 nH	LQW18AN36NG00										
2.5 nH	LQW15AN2N5B80										
6.8 pF	GJM1555C1H6R8WB01										
3.6 nH	LQW15AN3N6B80										
824 – 960 MHz	 <table border="1" style="float: right;"> <thead> <tr> <th>Value</th> <th>Part Number</th> </tr> </thead> <tbody> <tr> <td>43 nH</td> <td>LQW18AN43NG00</td> </tr> <tr> <td>2.2 nH</td> <td>LQW15AN2N2B80</td> </tr> <tr> <td>12 pF</td> <td>GJM1555C1H120FB01</td> </tr> <tr> <td>4.7 pF</td> <td>GJM1555C1H4R7WB01</td> </tr> </tbody> </table>	Value	Part Number	43 nH	LQW18AN43NG00	2.2 nH	LQW15AN2N2B80	12 pF	GJM1555C1H120FB01	4.7 pF	GJM1555C1H4R7WB01
Value	Part Number										
43 nH	LQW18AN43NG00										
2.2 nH	LQW15AN2N2B80										
12 pF	GJM1555C1H120FB01										
4.7 pF	GJM1555C1H4R7WB01										
1710 – 2690 MHz	 <table border="1" style="float: right;"> <thead> <tr> <th>Value</th> <th>Part Number</th> </tr> </thead> <tbody> <tr> <td>3.3 nH</td> <td>LQW15AN3N3B80</td> </tr> <tr> <td>3.3 nH</td> <td>LQW15AN3N3B80</td> </tr> <tr> <td>1.4 pF</td> <td>GJM1555C1H1R4WB01</td> </tr> </tbody> </table>	Value	Part Number	3.3 nH	LQW15AN3N3B80	3.3 nH	LQW15AN3N3B80	1.4 pF	GJM1555C1H1R4WB01		
Value	Part Number										
3.3 nH	LQW15AN3N3B80										
3.3 nH	LQW15AN3N3B80										
1.4 pF	GJM1555C1H1R4WB01										

Figure 2 – Matching networks implemented in the Evaluation Board 3 ports (Figure 1).

These matching networks apply to this Evaluation Board. Other configurations would require a matching network adjustment. Please contact info@fractusantennas.com for more information related to the antenna booster matching service.

2.2.2. VSWR and TOTAL Efficiency

VSWR (Voltage Standing Wave Ratio) and Total Efficiency versus Frequency (GHz).

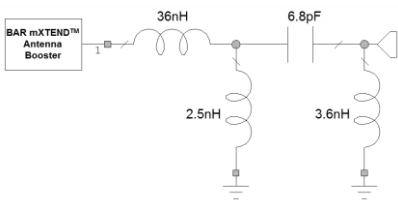
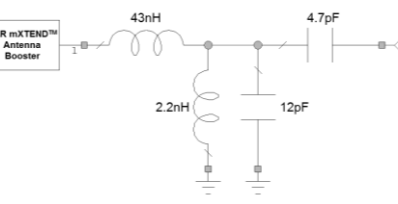
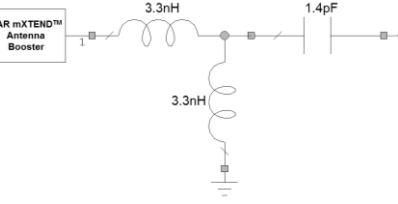
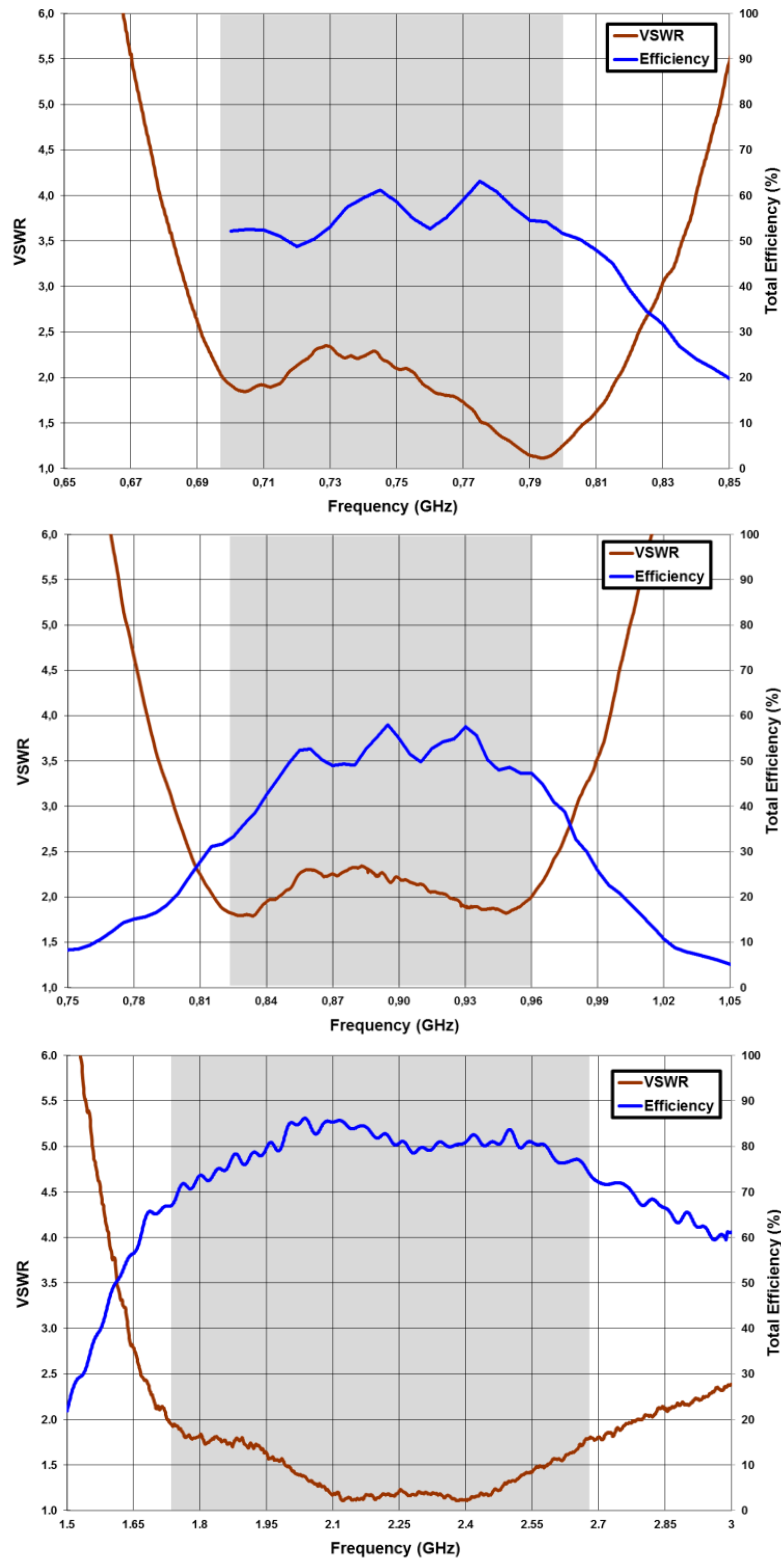

Figure 3 – VSWR and Total Efficiency for the 698 – 798 MHz range, for the 824 – 960 MHz range, and for the 1710 – 2690 MHz range from the Evaluation Board 3 ports (Figure 1).

2.2.3. Transmission coefficient

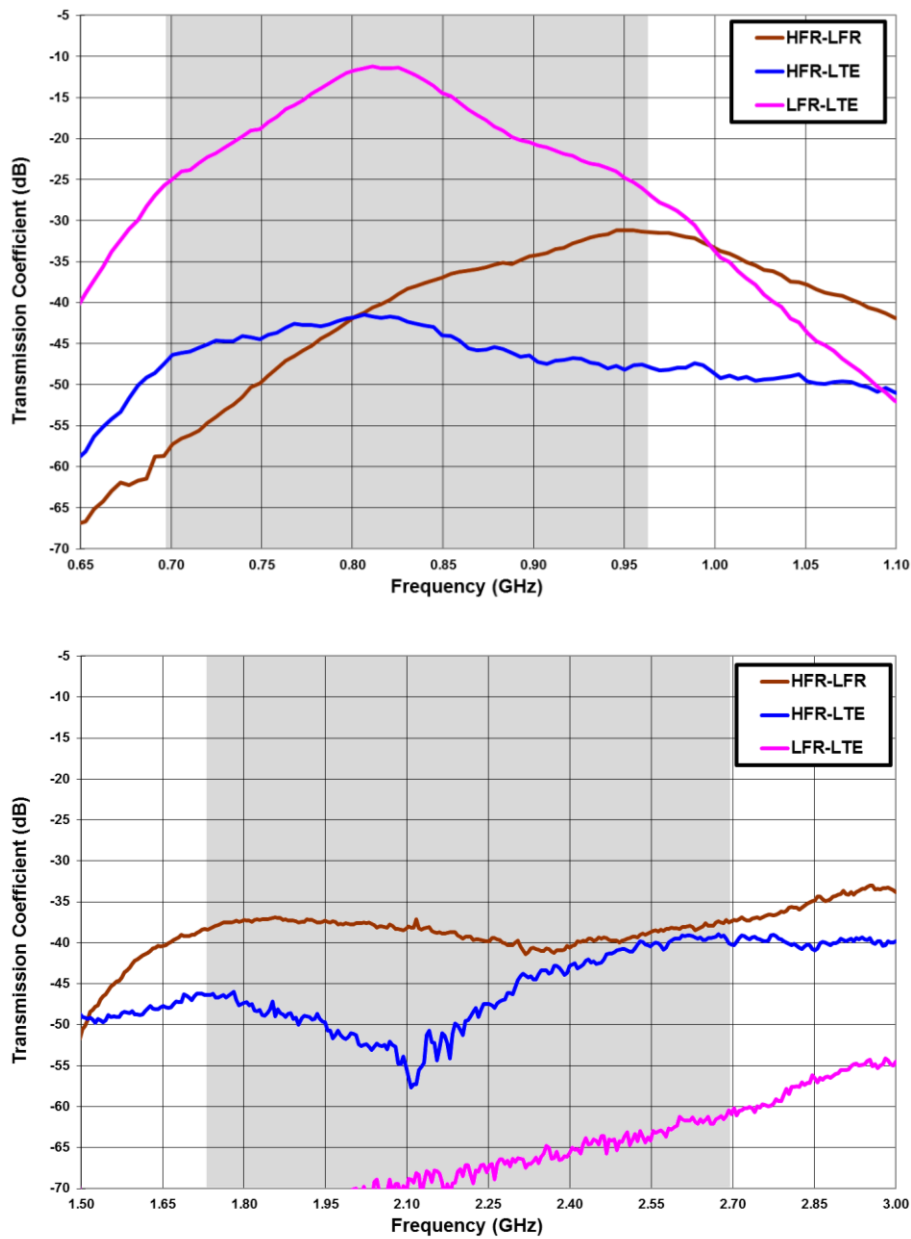
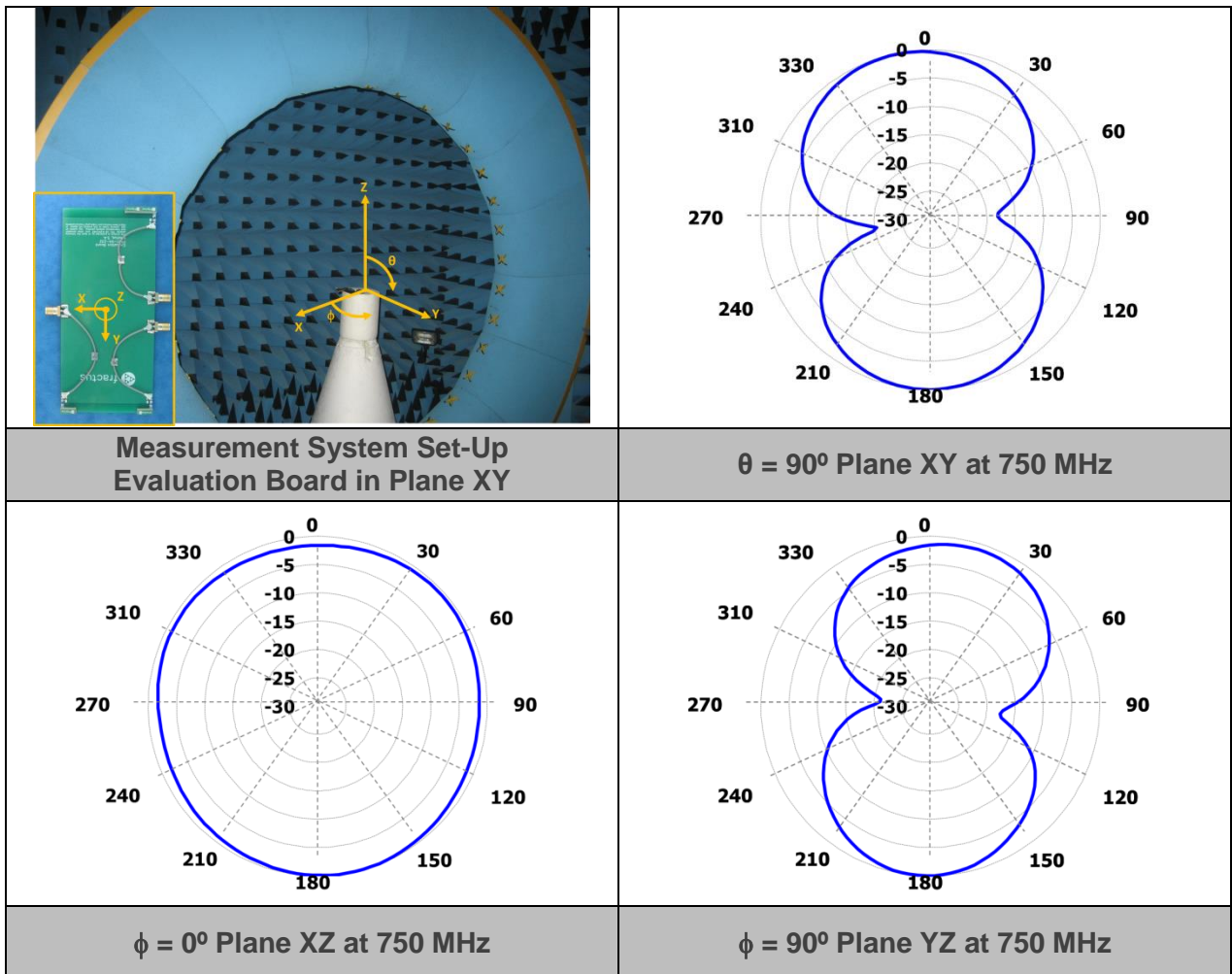

Figure 4 – Transmission coefficient for the 698-798 MHz range (LTE), for 824 – 960 MHz range (LFR), and for the 1710 – 2690 MHz range (HFR) (from the Evaluation Board 3 ports) (Figure 1).

2.2.4. RADIATION PATTERNS (698-798 MHz), GAIN, AND EFFICIENCY



Gain	Peak Gain	1.3 dBi
	Average Gain across the band	0.3 dBi
	Gain Range across the band (min, max)	-0.6 <-> 1.3 dBi
Efficiency	Peak Efficiency	63.1 %
	Average Efficiency across the band	55.5 %
	Efficiency Range across the band (min, max)	48.8 – 63.1 %

Table 2 – Antenna Gain and Total Efficiency from the Evaluation Board (Figure 1) within the 698 – 798 MHz range. Measures made in the Satimo STARGATE 32 anechoic chamber.

2.2.5. RADIATION PATTERNS (824-960 MHz), GAIN, AND EFFICIENCY

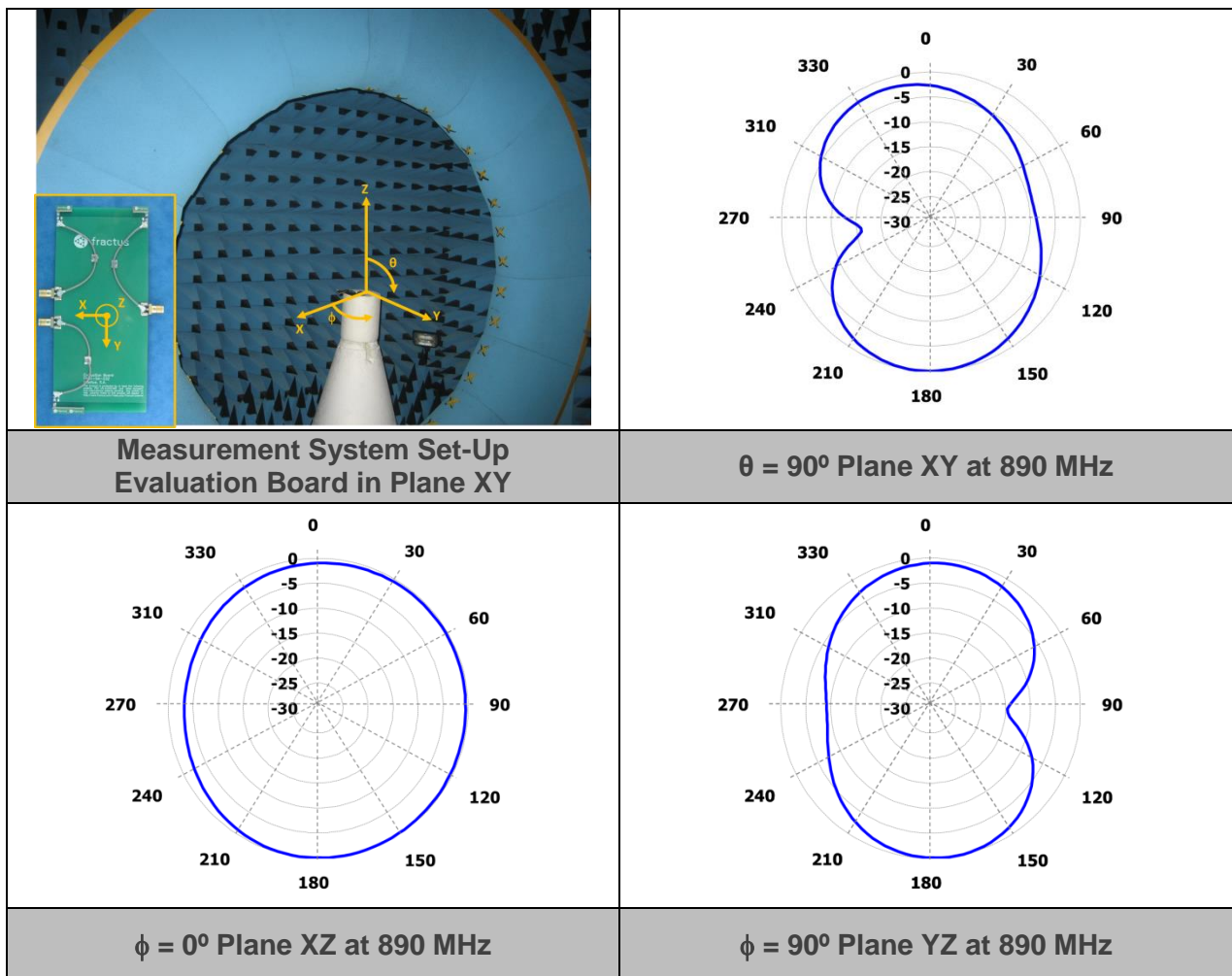

Gain	Peak Gain	0.3 dBi
	Average Gain across the band	-0.3 dBi
	Gain Range across the band (min, max)	-2.2 <--> 0.3 dBi
Efficiency	Peak Efficiency	58.0 %
	Average Efficiency across the band	49.8 %
	Efficiency Range across the band (min, max)	33.0 – 58.0 %

Table 3 – Antenna Gain and Total Efficiency from the Evaluation Board (Figure 1) within then 824 – 960 MHz range. Measures made in the Satimo STARGATE 32 anechoic chamber.

2.2.6. RADIATION PATTERNS (1710-2690 MHz), GAIN, AND EFFICIENCY

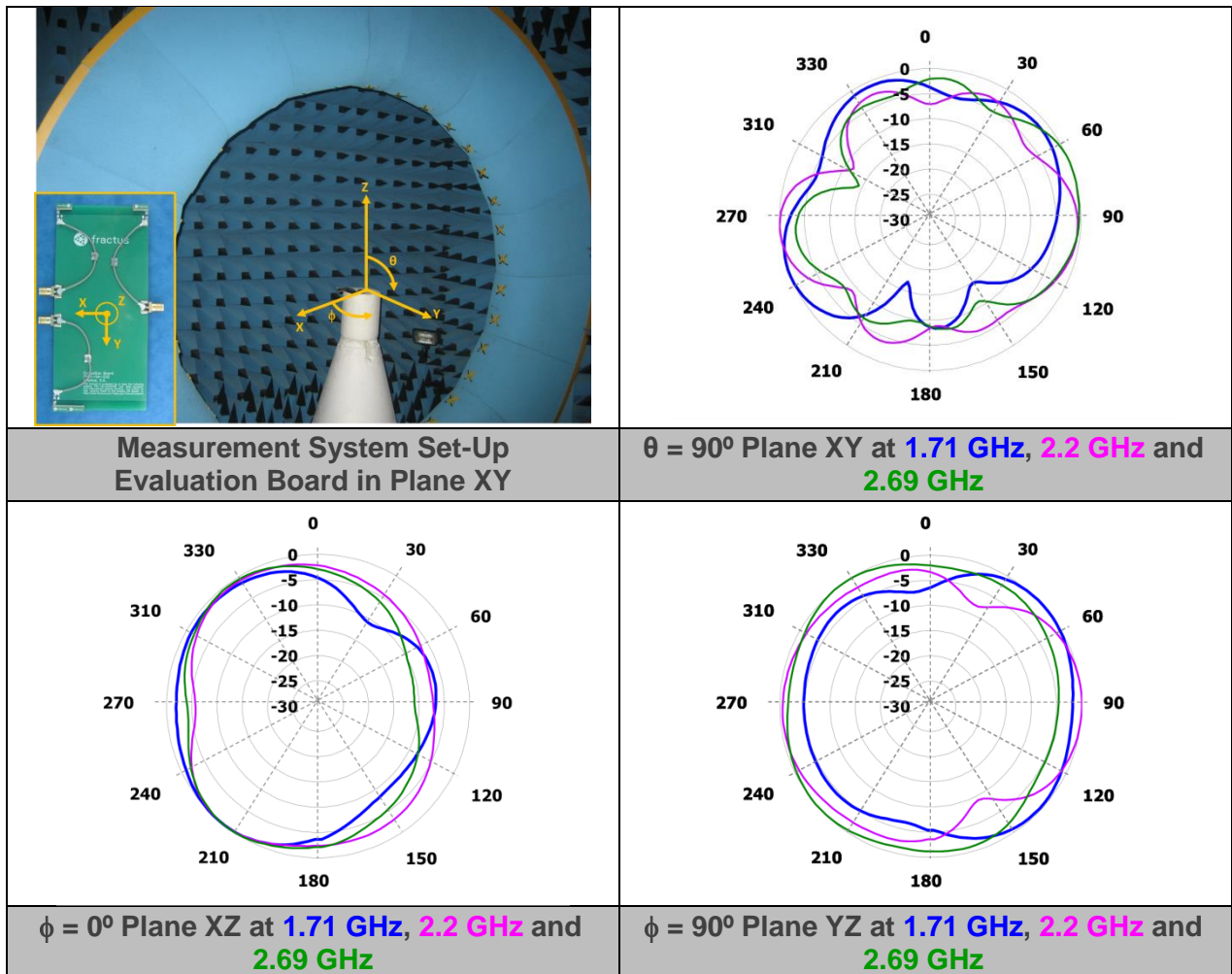

Gain	Peak Gain	3.8 dBi
	Average Gain across the band	3.1 dBi
	Gain Range across the band (min, max)	1.9 <-> 3.8 dBi
Efficiency	Peak Efficiency	87.9 %
	Average Efficiency across the band	79.3 %
	Efficiency Range across the band (min, max)	65.9 – 87.9 %

Table 4 – Antenna Gain and Total Efficiency from the Evaluation Board (Figure 1) within the 1710 – 2690 MHz range. Measures made in the Satimo STARGATE 32 anechoic chamber.

3. EVALUATION BOARD 1 PORT (824-960MHz and 1710-2690MHz)

3.1. QUICK REFERENCE GUIDE

Technical features	824 – 960 MHz	1710 – 2690 MHz
Average Efficiency	> 50.0 %	> 65.0 %
Peak Gain	0.7 dBi	2.9 dBi
VSWR	< 3:1	
Radiation Pattern	Omnidirectional	
Polarization	Linear	
Weight (approx.)	0.21 g.	
Temperature	-40 to + 85 °C	
Impedance	50 Ω	
Dimensions (L x W x H)	10.0 mm x 3.2 mm x 3.2 mm	

Table 5 – Technical Features. Measures from the Evaluation Board. See Figure 5. Note that for obtaining comparable results, a ground plane length larger than 100 mm is recommended.

3.2. EVALUATION BOARD 1 PORT (824-960 MHz and 1710-2690 MHz)

This Evaluation Board (part number: EB_FR01-S4-232-UFL2R-1P) integrates two BAR mXTEND™ Antenna Boosters to provide operation in two frequency regions, from 824 MHz to 960 MHz and from 1710 MHz to 2690 MHz. The two BAR mXTEND™ Antenna Boosters are connected between them through a 50 ohms impedance transmission line, in such a way that a single input/output port is provided. A UFL cable connects this single input/output port to the SMA connector.

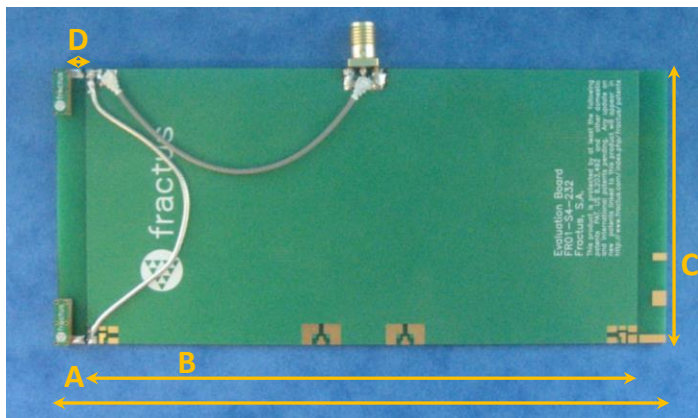

Measure	mm
A	133
B	120
C	60
D	3.3

Tolerance: ±0.2 mm

D: Distance between the BAR mXTEND™ Antenna Booster and the ground plane.

Material: The Evaluation Board is built on FR4 substrate. Thickness is 1 mm.

Figure 5 – EB_FR01-S4-232-UFL2R-1P. Evaluation Board 1 port providing operation in 2 frequency ranges, 824 – 960MHz and 1710 – 2690MHz.

This product is protected by at least the following [patents](#) PAT. US 8,203,492, PAT. US 8,237,615 and other domestic and international patents pending. Any update on new patents linked to this product will appear in www.fractusantennas.com/virtual-antenna/.

3.2.1. MATCHING NETWORK

The specs of a Fractus Antennas standard product are measured in their Evaluation Board, which is an ideal case. In a real design, components nearby the antenna, LCD's, batteries, covers, connectors, etc. affect the antenna performance. This is the reason why it is highly recommended placing pads compatible with 0402 and 0603 SMD components for a matching network as close as possible to the feeding point. Do it in the ground plane area, not in the clearance area. This provides a degree of freedom to tune the BAR mXTEND™ Antenna Booster once the design is finished and taking into account all elements of the system (batteries, displays, covers, etc.).

Please notice that different devices with different ground planes and different components nearby the BAR mXTEND™ Antenna Booster may need a different matching network. To ensure optimal results, the use of high Q and tight tolerance components is highly recommended (Murata components).

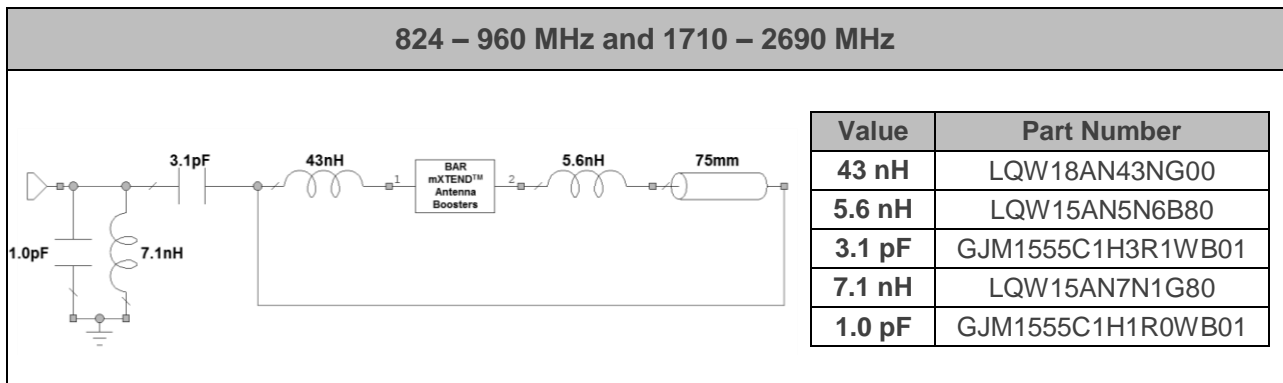

Figure 6 – Matching network implemented in the Evaluation Board 1 port (Figure 5).

Please note that the matching network includes a 50 ohms impedance micro coaxial transmission line having a length of 75 mm. To ensure optimal results, good grounding between the transmission line shielding and the ground plane is highly recommended. This matching network applies to this Evaluation Board. Other configurations would require a matching network adjustment. Please contact info@fractusantennas.com for more information related to the antenna booster matching service.

3.2.2. VSWR and TOTAL Efficiency

VSWR (Voltage Standing Wave Ratio) and Total Efficiency versus Frequency (GHz).

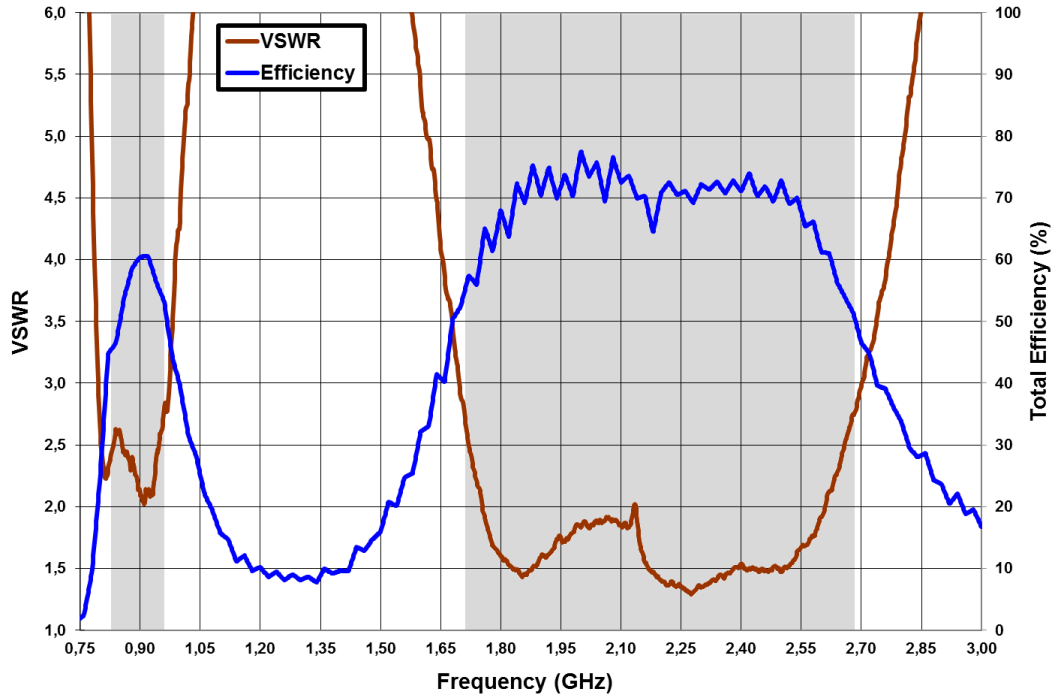
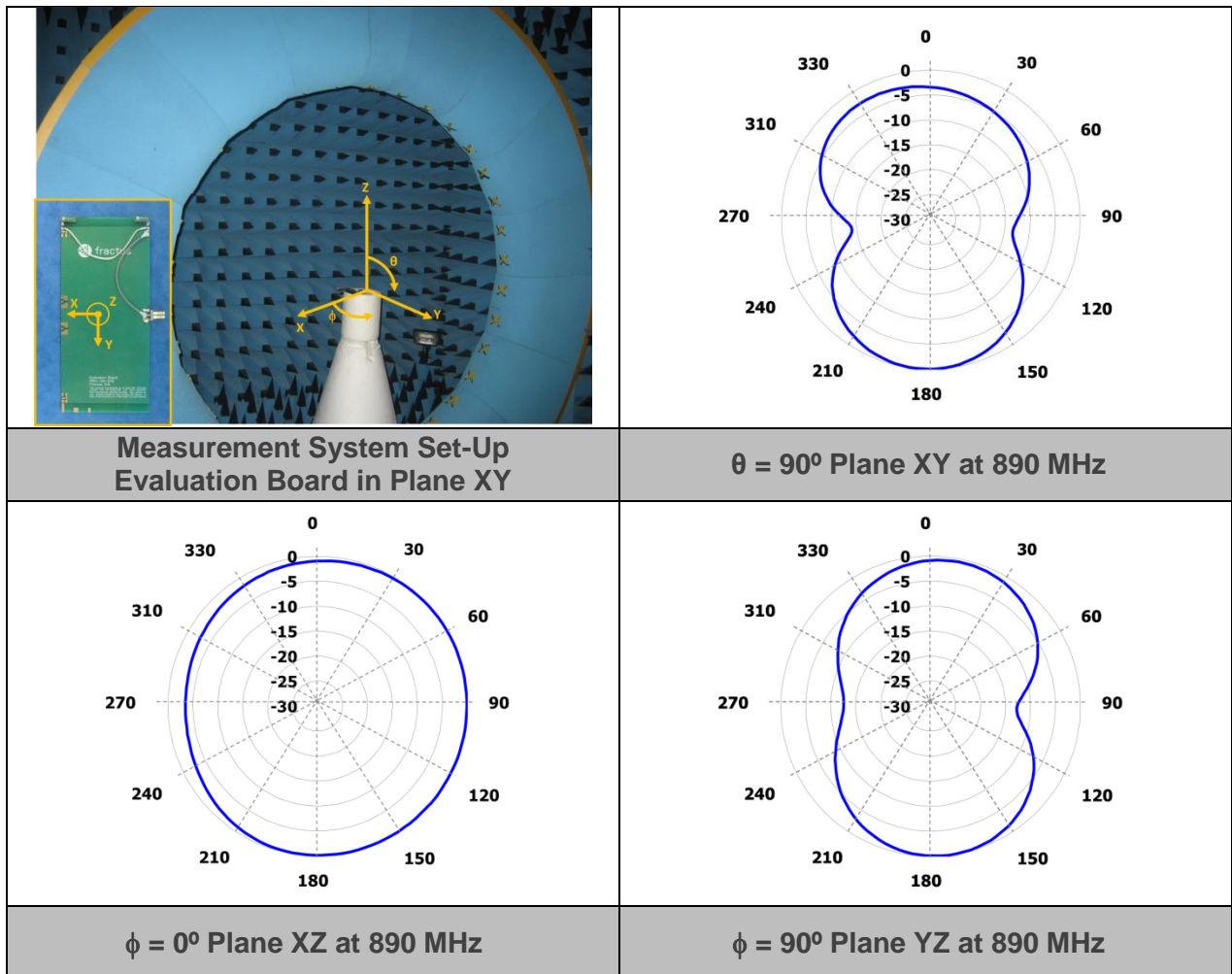

Figure 7 – VSWR and Total Efficiency for the 824 – 960 MHz frequency range and for the 1710 – 2690 MHz frequency range (from the Evaluation Board) (Figure 5).

3.2.3. RADIATION PATTERNS (824-960 MHz), GAIN, AND EFFICIENCY



Gain	Peak Gain	0.7 dBi
	Average Gain across the band	0.3 dBi
	Gain Range across the band (min, max)	-0.5 <--> 0.7 dBi
Efficiency	Peak Efficiency	60.6 %
	Average Efficiency across the band	55.3 %
	Efficiency Range across the band (min, max)	45.1 – 60.6 %

Table 6 – Antenna Gain and Total Efficiency from the Evaluation Board (Figure 5) within the 824 – 960 MHz frequency range. Measures made in the Satimo STARGATE 32 anechoic chamber.

3.2.4. RADIATION PATTERNS (1710-2690 MHz), GAIN, AND EFFICIENCY

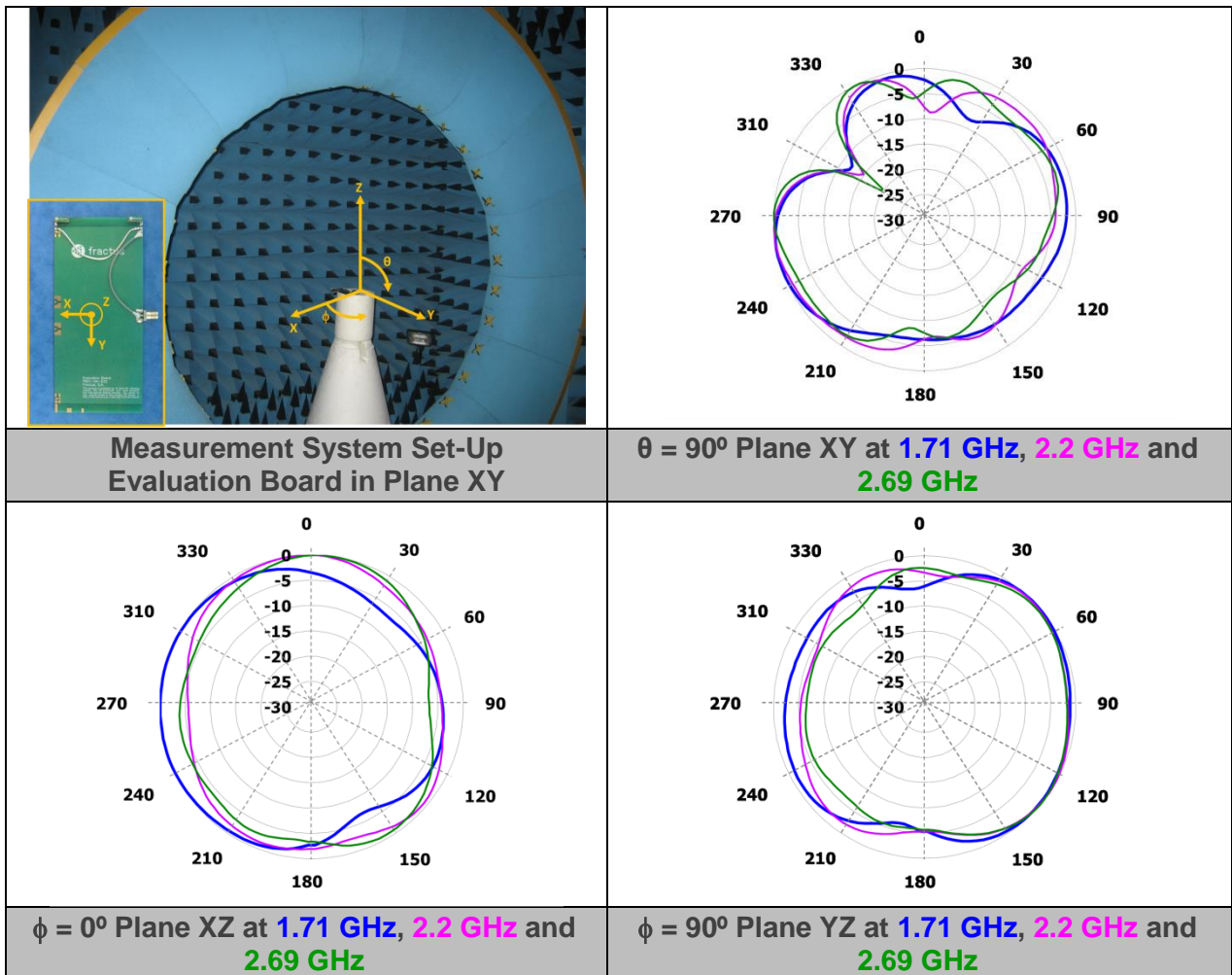

Gain	Peak Gain	2.9 dBi
	Average Gain across the band	2.3 dBi
	Gain Range across the band (min, max)	1.0 <--> 2.9 dBi
Efficiency	Peak Efficiency	77.5 %
	Average Efficiency across the band	68.7 %
	Efficiency Range across the band (min, max)	48.7 – 77.5 %

Table 7 – Antenna Gain and Total Efficiency from the Evaluation Board (Figure 5) within the 1710 – 2690 MHz frequency range. Measures made in the Satimo STARGATE 32 anechoic chamber.

4. CAPABILITIES AND MEASUREMENT SYSTEMS

Fractus Antennas specializes in designing and manufacturing optimized antennas for wireless applications and providing our clients with RF expertise. We offer turn-key antenna products and antenna integration support to minimize your time requirement and maximize your return on investment during your product development efforts. We also provide our clients with the opportunity to leverage our in-house testing and measurement facilities to obtain accurate results quickly and efficiently.



Agilent E5071B

VSWR
&
S Parameters

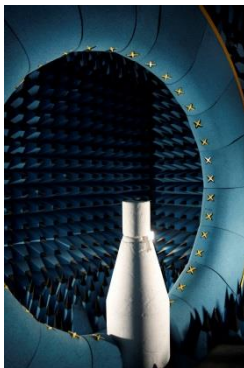
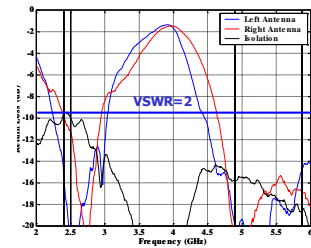

SATIMO STARGATE 32

Radiation
Pattern
&
Efficiency

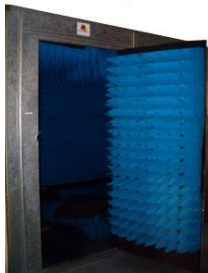
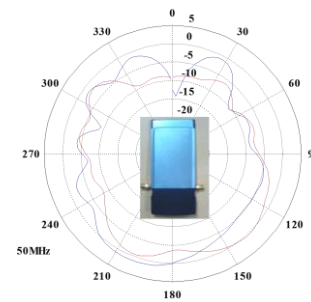

Anechoic chambers and full equipped in-house lab

5. MECHANICAL CHARACTERISTICS FR01-S4-232

5.1. DIMENSIONS, TOLERANCES, AND RoHS

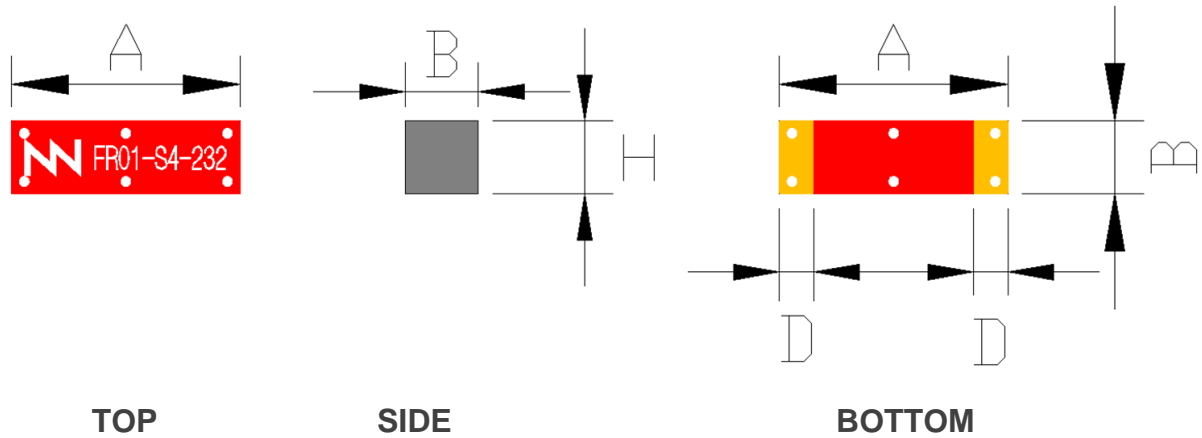

Dimension	mm	Dimension	mm
A	10.0 ± 0.2	B	3.2 ± 0.2
C	0.5 ± 0.1	D	1.5 ± 0.1
H (Height)	3.2		+0.2 -0.1

Figure 8 – BAR mXTEND™ Antenna Booster dimensions and tolerances.

The 2 pads are fully symmetrical to mount it on the PCB. See Figure 11.

The BAR mXTEND™ Antenna Booster FR01-S4-232 is compliant with the restriction of the use of hazardous substances (**RoHS**).

The RoHS certificate can be downloaded from www.fractusantennas.com.

5.2. COLOUR RANGE FOR THE INK

Next figure shows the range of the colours in the BAR mXTEND™ Antenna Booster:

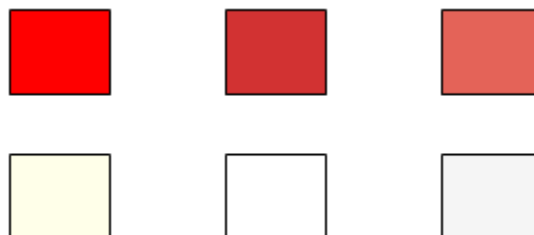

Acceptable color range

5.3. RECOMMENDED FOOTPRINT for the FR01-S4-232

Assuming that the BAR mXTEND™ Antenna Booster FR01-S4-232 is placed in the clearance area of the PCB, see below the recommended footprint dimensions.

Measure	mm
A	1.7
B	6.8
C	3.4

Tolerance: ±0.1 mm

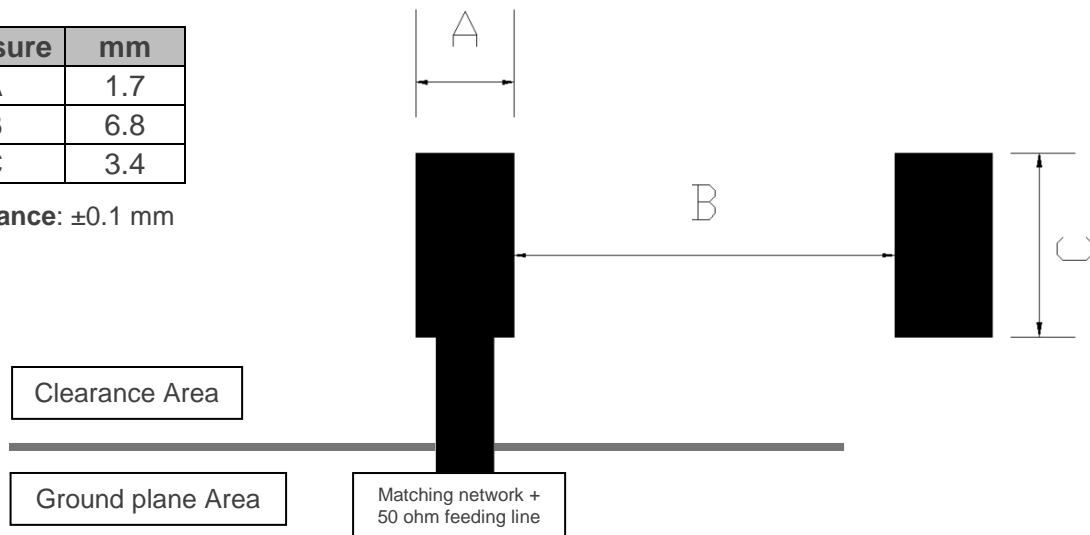

Figure 9 – Footprint dimensions for the single booster.

For additional support in the integration process, please contact info@fractusantennas.com.

5.4. RECOMMENDED FOOTPRINT for the FR01-S4-232 double booster

Measure	mm
A	1.7
B	6.8
C	3.4
D	3.3

Tolerance: ±0.1 mm

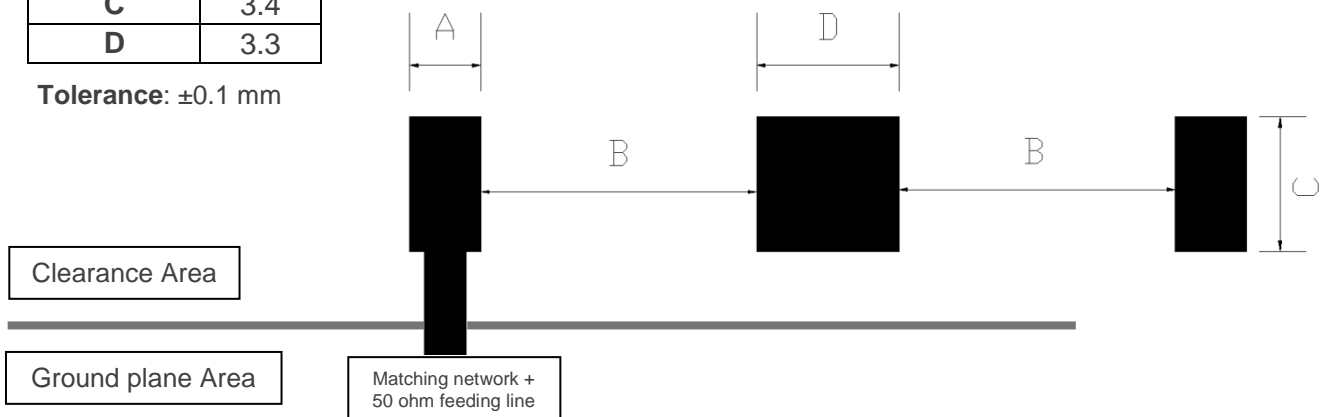

Figure 10 – Footprint dimensions for the double booster.

For additional support in the integration process, please contact info@fractusantennas.com.

6. ASSEMBLY PROCESS

Figure 11 shows the back and front view of the BAR mXTEND™ Antenna Booster FR01-S4-232. Due to the symmetry in the product configuration, the feeding pad can be any of the 2 pads.

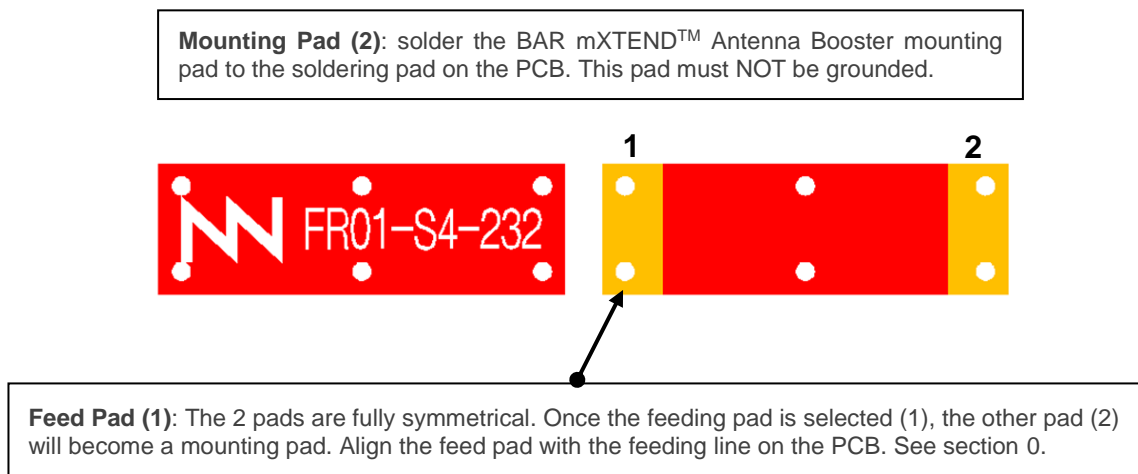

Figure 11 – Pads of the BAR mXTEND™ Antenna Booster FR01-S4-232.

As a surface mount device (SMD), the BAR mXTEND™ Antenna Booster is compatible with industry standard soldering processes. The basic assembly procedure for the BAR mXTEND™ Antenna Booster is as follows:

1. Apply a solder paste on the pads of the PCB. Place the BAR mXTEND™ Antenna Booster on the board.
2. Perform a reflow process according to the temperature profile detailed in Table 8, Figure 13.
3. After soldering the BAR mXTEND™ Antenna Booster to the circuit board, perform a cleaning process to remove any residual flux. Fractus Antennas recommends conducting a visual inspection after the cleaning process to verify that all reflux has been removed.

The drawing below shows the soldering details obtained after a correct assembly process:

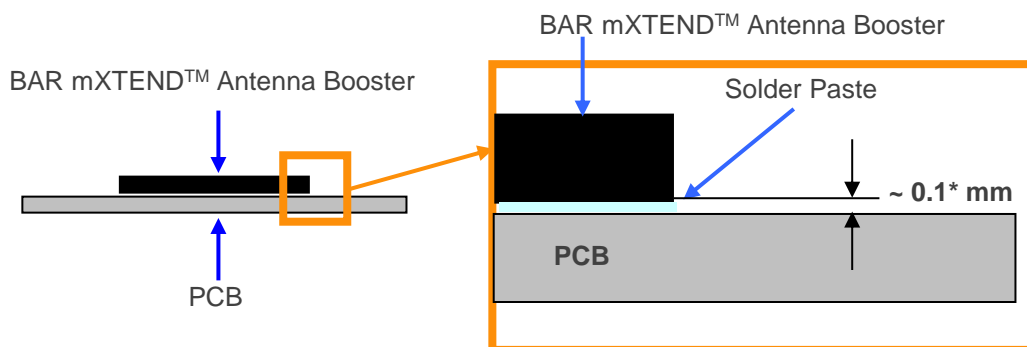

Figure 12 – Soldering Details.

NOTE(*): Solder paste thickness after the assembly process will depend on the thickness of the soldering stencil mask. A stencil thickness equal or larger than **127 microns (5 mils)** is required.

The BAR mXTEND™ Antenna Booster FR01-S4-232 can be assembled following the Pb-free assembly process. According to the Standard **IPC/JEDEC J-STD-020C**, the temperature profile suggested is as follows:

Phase	Profile features	Pb-Free Assembly (SnAgCu)
RAMP-UP	Avg. Ramp-up Rate (T _{smax} to T _p)	3 °C / second (max.)
PREHEAT	- Temperature Min (T _{smin}) - Temperature Max (T _{smax}) - Time (t _{smin} to t _{smax})	150 °C 200 °C 60-180 seconds
REFLOW	- Temperature (T _L) - Total Time above T _L (t _L)	217 °C 60-150 seconds
PEAK	- Temperature (T _p) - Time (t _p)	260 °C 20-40 seconds
RAMP-DOWN	Rate	6 °C/second max
Time from 25 °C to Peak Temperature		8 minutes max

Table 8 – Recommended soldering temperatures.

Next graphic shows temperature profile (grey zone) for the BAR mXTEND™ Antenna Booster assembly process reflow ovens.

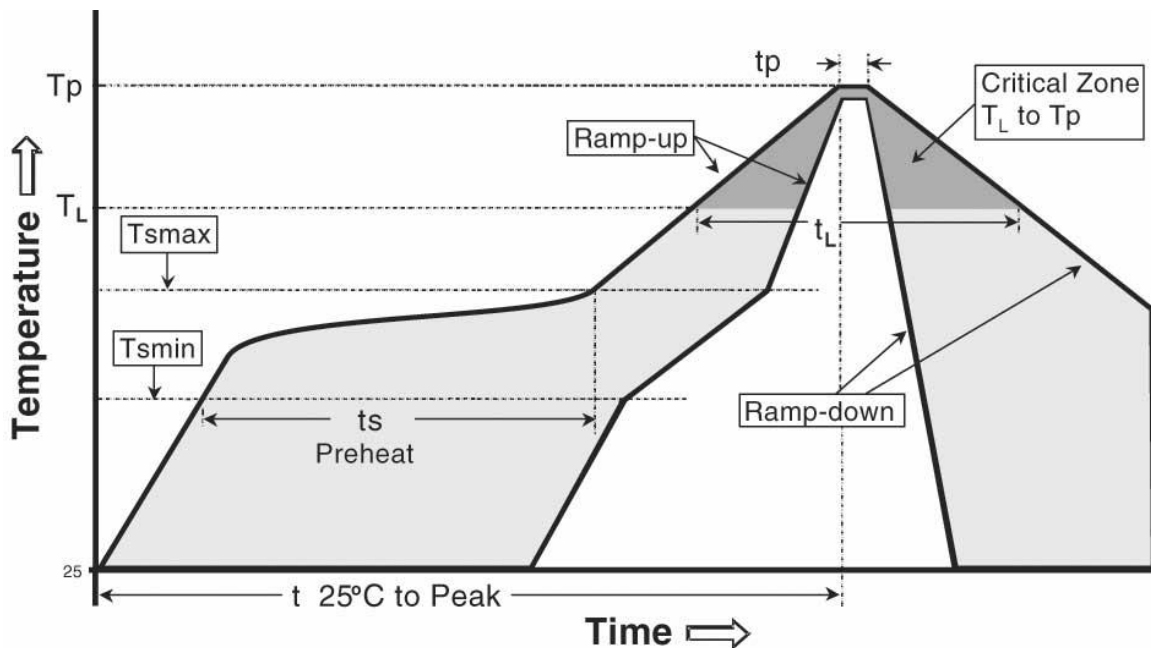

Figure 13 – Temperature profile.

7. PACKAGING

The BAR mXTEND™ Antenna Booster FR01-S4-232 is delivered in tape and reel packaging.

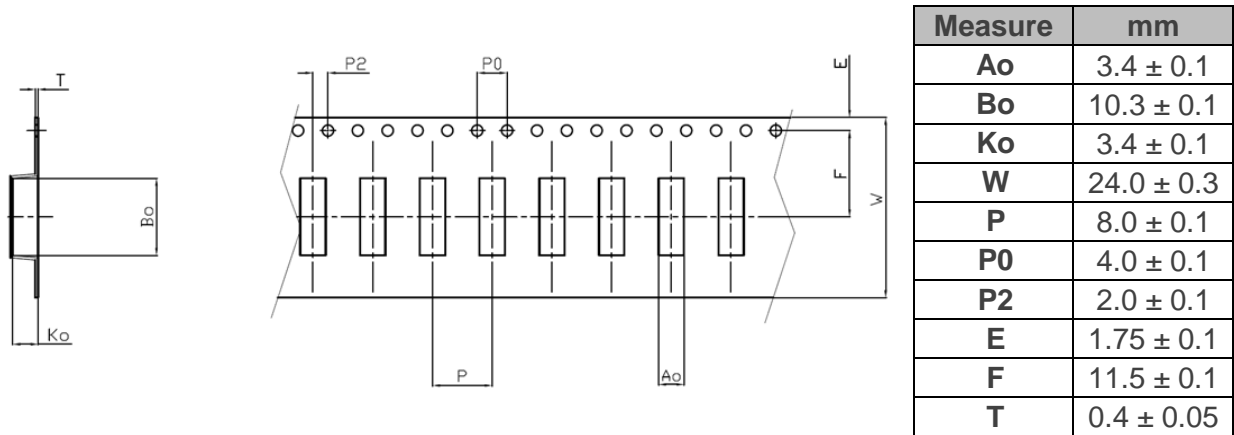

Figure 14 – Tape dimensions and Tolerances.

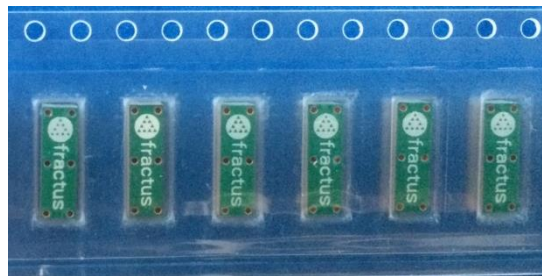
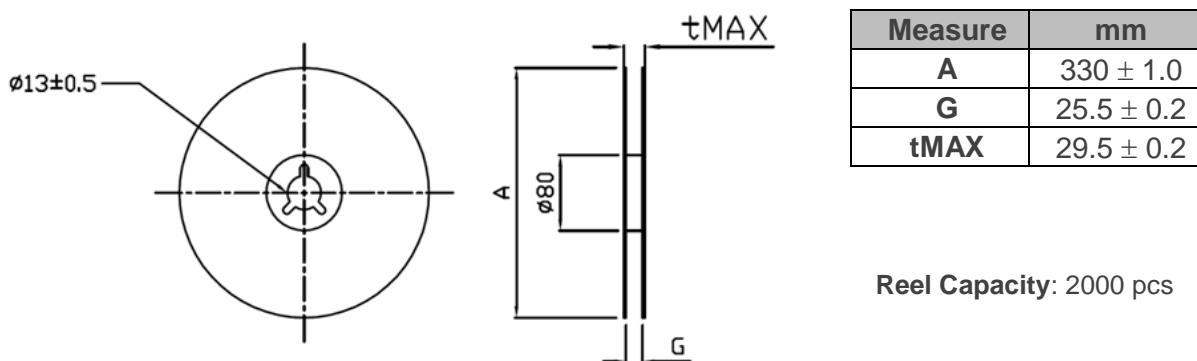

Figure 15 – Image of the tape.



Reel Capacity: 2000 pcs

Figure 16 – Reel Dimensions and Capacity.